

# NORCOLD



# Refrigerator Service Manual

---

## **Models:**

**DC440, DC451, DC490**

**DE441, DE451, DE461, DE490**

**MRFT415, MRFT440, MRFT460**

NORCOLD, INC.  
P.O BOX 4248  
SIDNEY, OH 45365-4248

## Trouble Shooting - Table of Contents

---

-- Procedure A - Thermostat "ON" Compressor does not run .....	3
-- Procedure B - Compressor Resistance .....	4
-- Procedure C - Power Supply Output Voltage .....	5
-- Procedure D - Compressor Amp Draw .....	6
-- Procedure E - Evaporator Thermister Resistance .....	7
-- Procedure F - Insufficient Coolling .....	8
-- Procedure G - Refrigerator to Cold .....	9
-- Procedure H - Auto Shut-OFF Device .....	10
-- Wiring Schematic .....	11
-- Procedure I - Ventilation .....	12-14
-- Quick Reference Repair Sheet .....	15



### **WARNING**

**Perform all tests using a fully charged 12 VDC battery. Using other equipment that supplies DC voltage may cause permanent refrigerator compressor failure.**

# Trouble Shooting - Procedure A

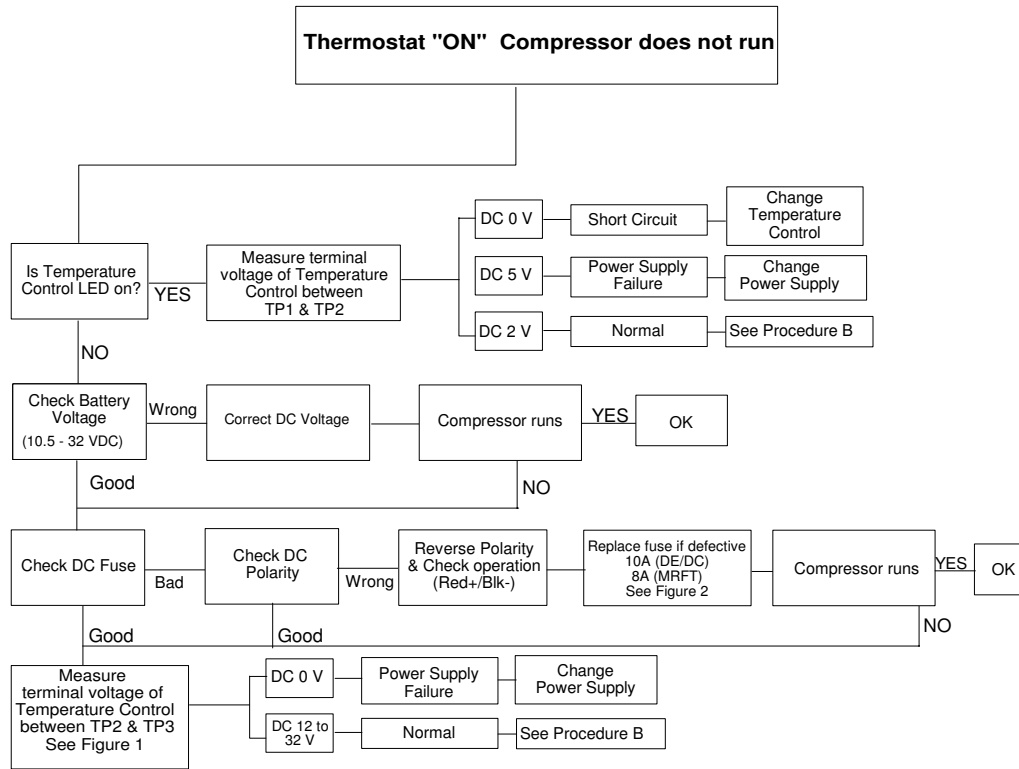

ART01190

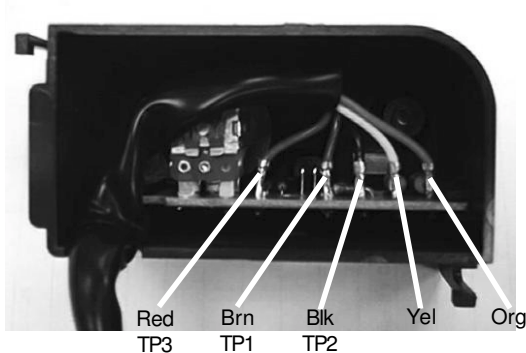

Figure 1 - Temperature Control

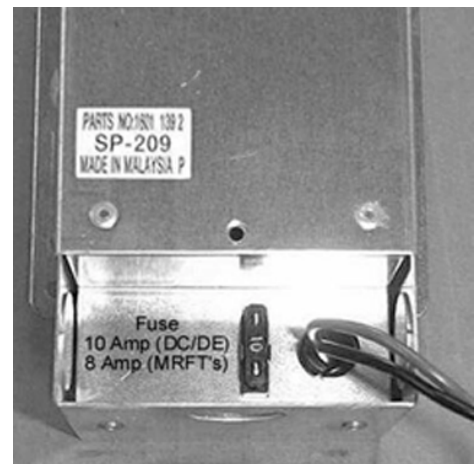
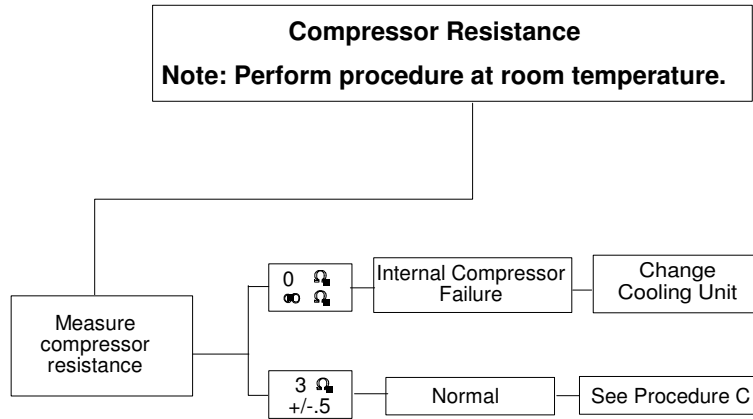

Figure 2 - Power Supply

Note:  
If 10 Amp fuse is blown, check wiring of vehicle

## Trouble Shooting - Procedure B

---



ART01192

---

Turn the refrigerator to OFF.

Remove the black wire to the compressor. Measure the resistance of the compressor between Point A and Point B.

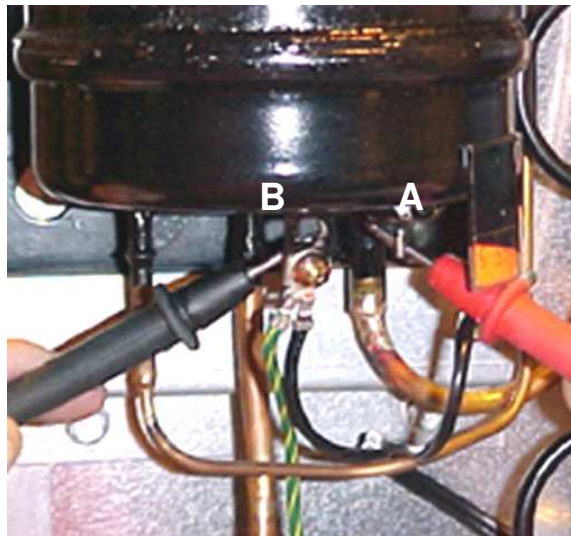

Figure 2 - Measuring Compressor Resistance

# Trouble Shooting - Procedure C

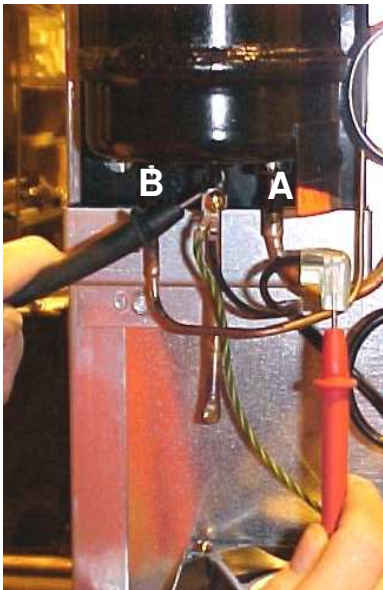
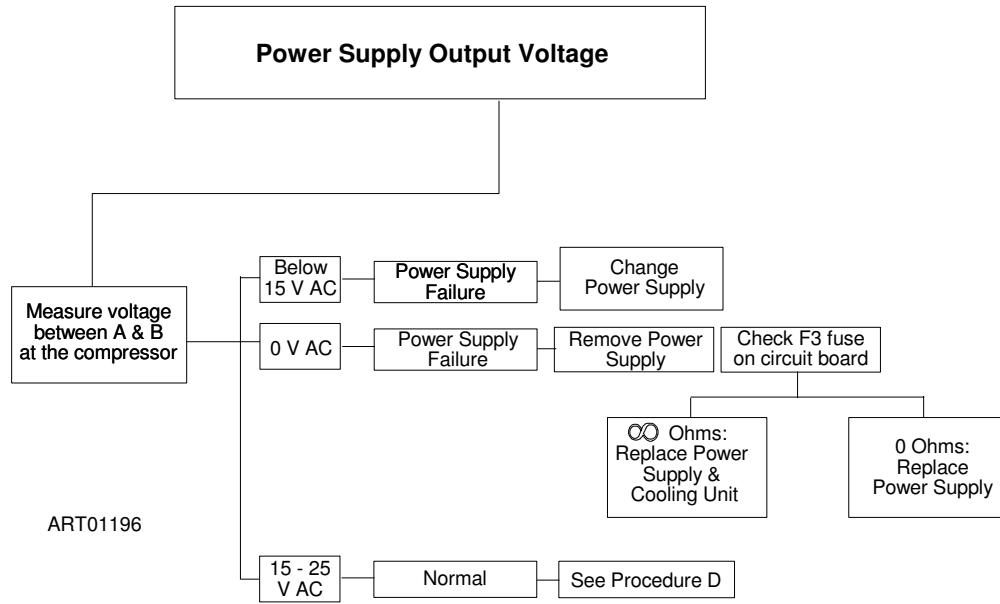

Figure 3 - Measuring Power Supply Output Voltage

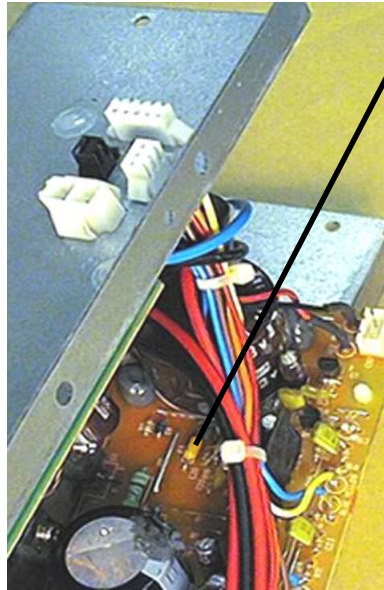

Figure 4 - DE Models only - F3 Fuse Location

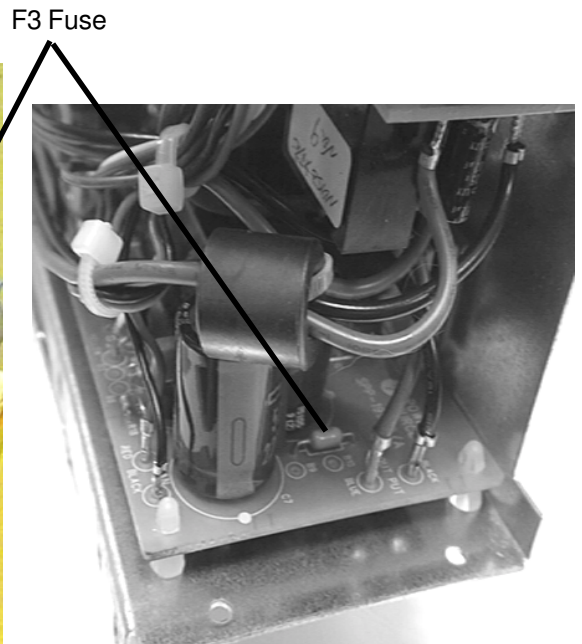
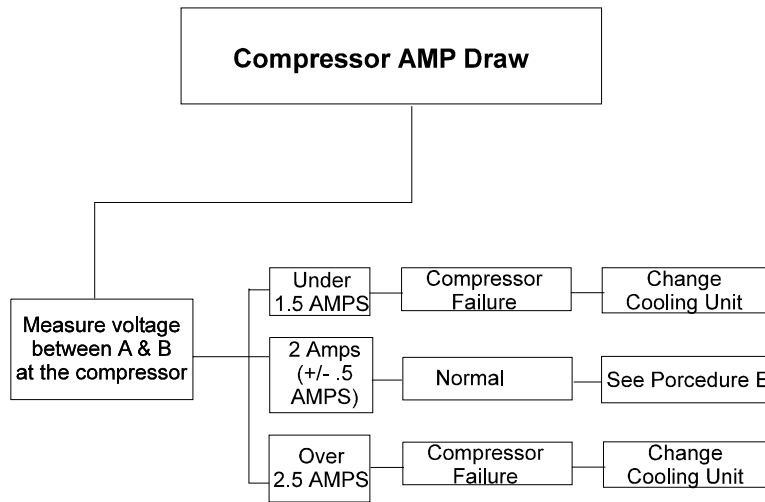

Figure 4A - DC Models only - F3 Fuse Location



ART01559

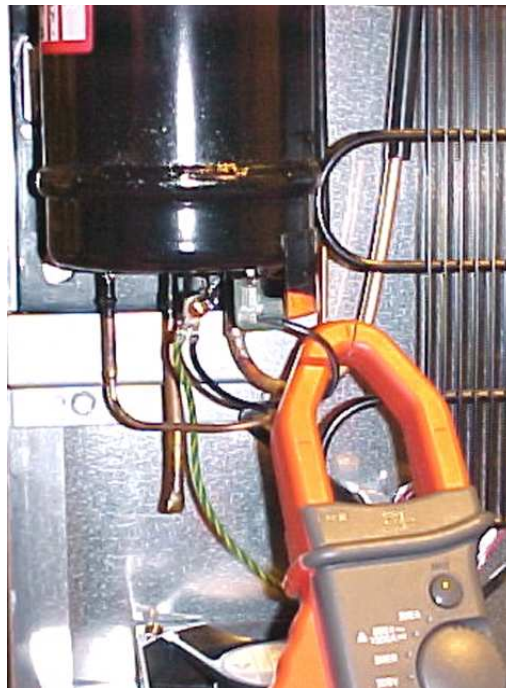

Figure 5 - Measuring Amp draw of Compressor

# Trouble Shooting - Procedure E

## Thermistor Check-Out

Turn the refrigerator to OFF to measure resistance of the Evaporator Thermistor.

Disconnect the three pole connector (Figure 6)  
Measure resistance (Figure 7).

The Evaporator Thermistor is checked by measuring the temperature and resistance of the Thermistor (Table 1).

1.6K - 29K  $\Omega$  = good Thermistor.

$\infty \Omega$  = open Thermistor windings. An open Thermistor will stop compressor operation.  
Replace Thermistor.

Table 1

Evaporator Thermistor Resistance		
Thermistor Temperature °F	Resistance	Allowable Resistance Range
0	9.7K	8.7K - 10.7K
10	7.8K	7.0K - 8.6K
20	6.4K	5.7K - 7.0K
30	5.3K	4.8K - 5.7K
40	4.5K	4.0K - 4.9K
50	3.6K	3.2K - 4.0K
60	2.8K	2.5K - 3.1K
70	2.1K	1.9K - 2.3K
80	1.9K	1.7K - 2.0K
90	1.8K	1.6K - 1.9K

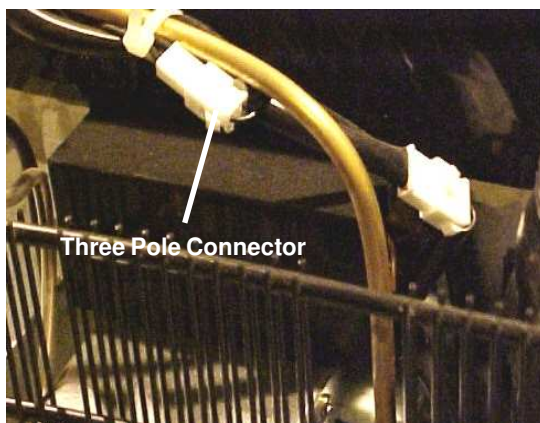

Figure 6 - Evaporator Thermistor

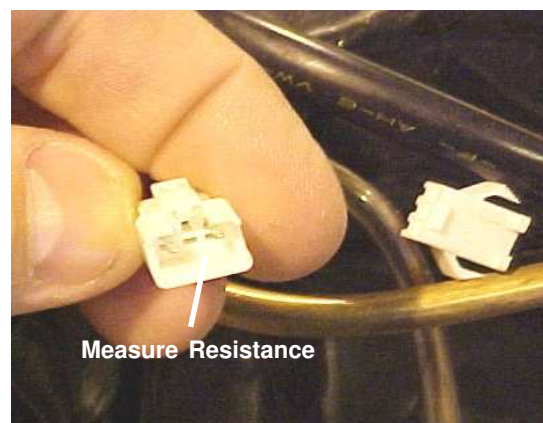

Figure 7 - Evaporator Thermistor





# Trouble Shooting - Procedure G

---

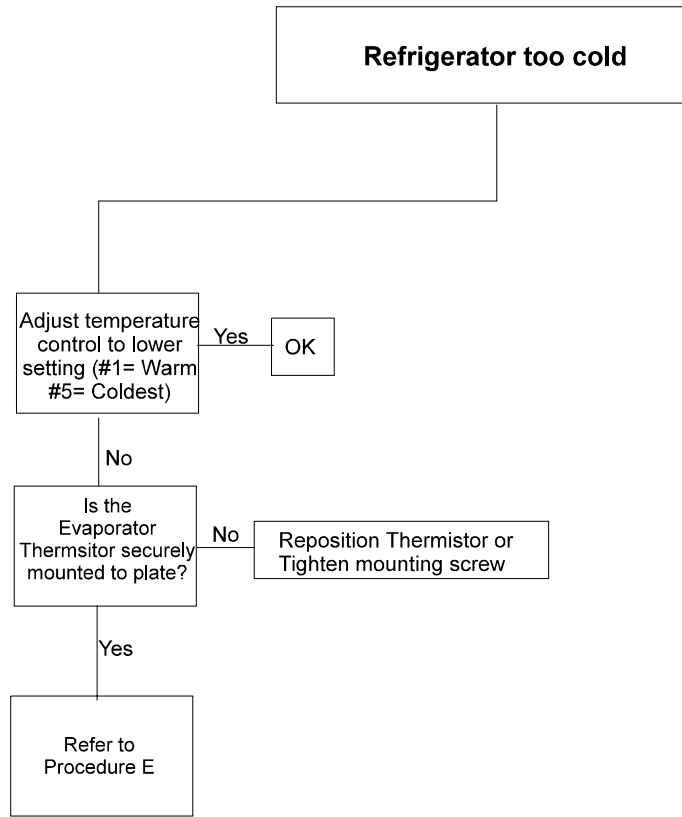

ART01200

# Trouble Shooting - Procedure H

## Auto-Shut Off Device

### Trouble Shooting Shut-Off Device



**WARNING**  
Do not operate refrigerator with Shut-OFF Device disconnected. Operating the refrigerator without device may cause compressor failure.

To determine if Shut-OFF Device is functional, disconnect the Shut-Off Device from the Temperature Control. Connect the Temperature Control direct to power supply. IF refrigerator operates, replace the Shut-OFF Device. If no operation, replace the Temperature Control.

### Overheating Shut-off Device Installation

1. Remove the wire [1] from the upper connection [2] of the POWER SUPPLY [3] (See Art01324).

2. Attach the SHUT-OFF DEVICE to the refrigerator:

NOTE: On some refrigerator models, remove the screw from the two (2) upper holes [4] of the POWER SUPPLY (See Art01324).

- Position the SHUT-OFF DEVICE [5] above the POWER SUPPLY and align the mounting holes of the SHUT-OFF DEVICE with the upper holes of the POWER SUPPLY (See Art01325).

- Put a screw through each mounting hole of the SHUT-OFF DEVICE, through the POWER SUPPLY and into the back of the refrigerator.

- Tighten each screw.

3. Connect the SHUT-OFF DEVICE wires to the refrigerator (See Art01325):

- Push the longer wire [6] of the SHUT-OFF DEVICE onto the upper connection of the POWER SUPPLY.

- Push the shorter wire [7] of the SHUT-OFF DEVICE onto the wire [1] that you removed in step #1.

### Overheating Shut-off Device Operation

The refrigerator will not restart until the refrigerator is manually turned off and the air temperature is lower than 110° F.

Operating the refrigerator in high ambient temperatures can overheat the cooling unit and cause premature failure of the compressor. (Refer to the label inside the refrigerator.)

To protect the cooling unit from overheating, the refrigerator will automatically shut-off when the vehicle air temperature is higher than 110° F. If shut off occurs, an audible alarm tone (an intermittent beeping) from the refrigerator will sound.

To stop the audible alarm tone and restart the refrigerator, you must turn the thermostat knob counterclockwise to "OFF" and then clockwise to the desired setting.

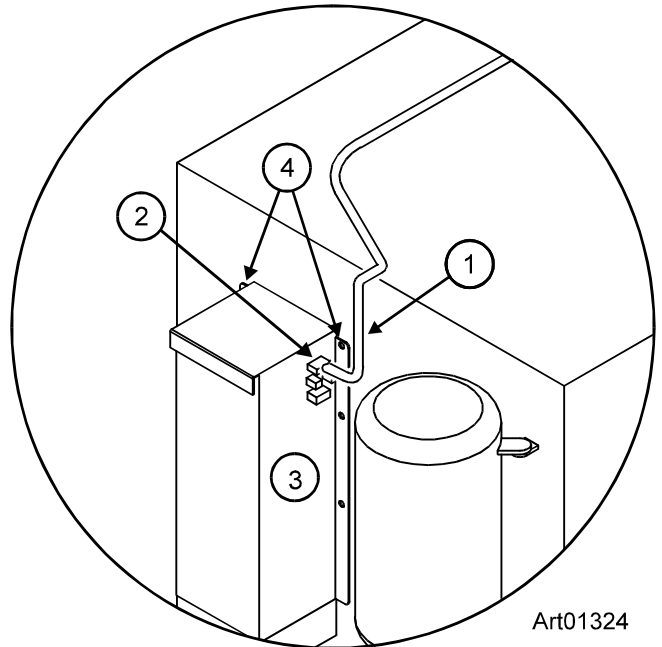

Art01324

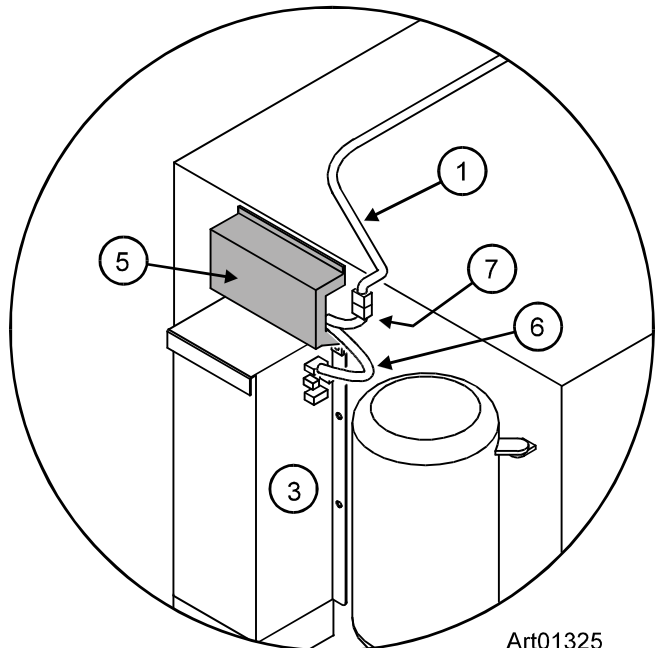

Art01325

# Trouble Shooting - Wiring Schematic

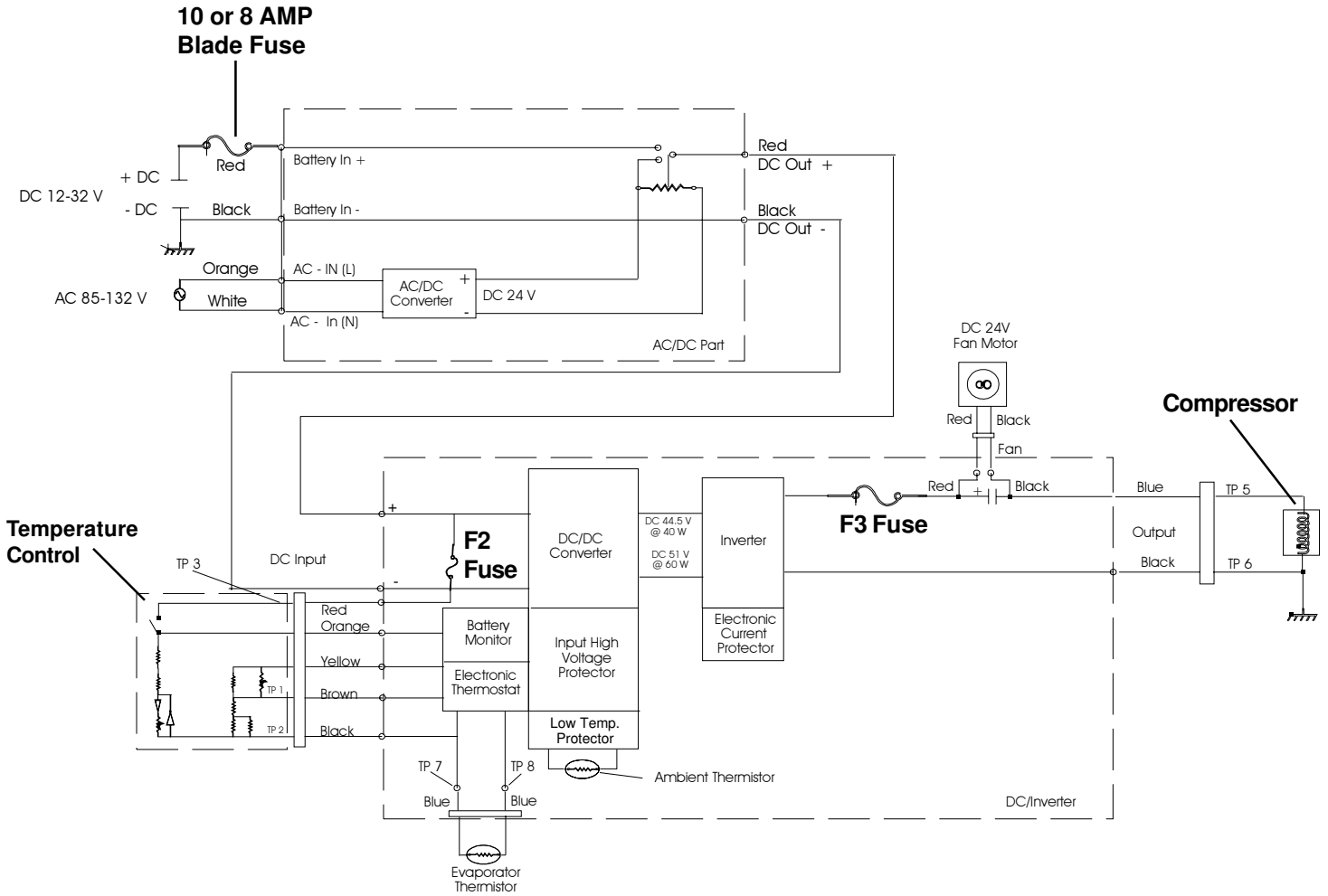

ART01204

## Ventilation - Procedure I

---

Ventilation is necessary for the correct operation of the refrigerator and to increase the life of the refrigerator cooling system. Ventilation allows the natural air flow that is necessary for good refrigeration. Cooler air comes in from the living area of the vehicle through a lower intake vent, goes around the refrigerator coils where it removes the excess heat from the refrigerator components, and goes out into the living area of the vehicle through an upper exhaust vent. If this air flow is blocked or decreased, the refrigerator will not cool correctly. **Do not install the vents into areas such as closets or cabinets.** Each refrigerator has specified **minimum** vent size requirements (See page 12). However, more air flow over the refrigerator coils increases the cooling performance of the refrigerator. If the construction of the vehicle does not allow you to install the vents into the living area of the vehicle, use any of the following approved vent combinations that are at the rear of the refrigerator (See Art01129).

 **CAUTION:**

Each refrigerator has specified **minimum** vent size requirements. Vent sizes that are less than the minimum requirements can cause:

- shortened life of the refrigerator cooling unit.
- poor cooling performance of the refrigerator.
- continuous operation of the refrigerator.
- fast battery discharge.
- void of the refrigerator warranty.

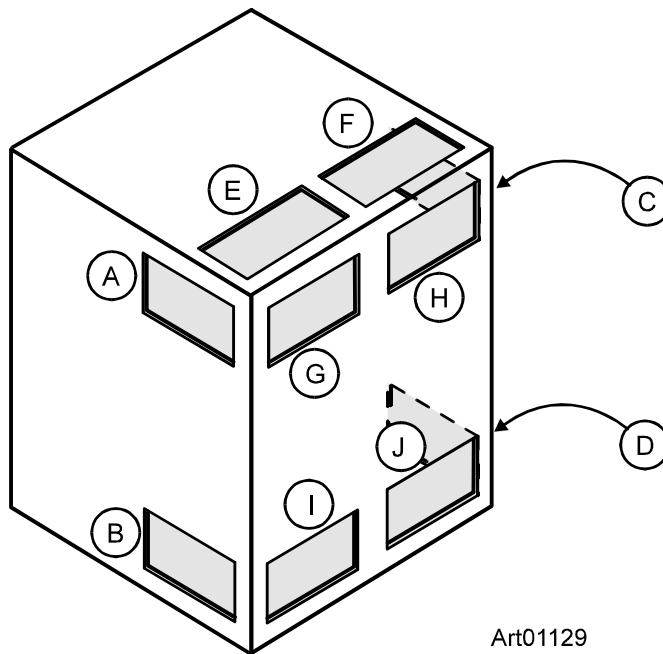

A/B, B/C, C/D, D/E, E/I, F/I, G/I; H/I  
A/D, B/E,,C/I, D/F, E/J, F/J, G/J, H/J  
A/I, B/F, C/J; D/G, A/J, B/G, D/H, B/H

## Ventilation - Procedure I

---

In addition to the required vents sizes, a fan can be added to increase the refrigerator performance and to decrease the refrigerator current consumption . A fan kit is available through Norcold part distribution network. Refer to Fan Kit Assembly chart on page 12.

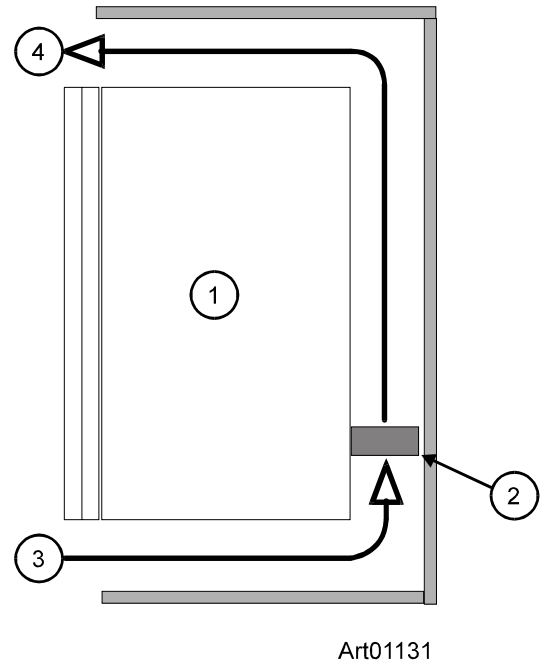
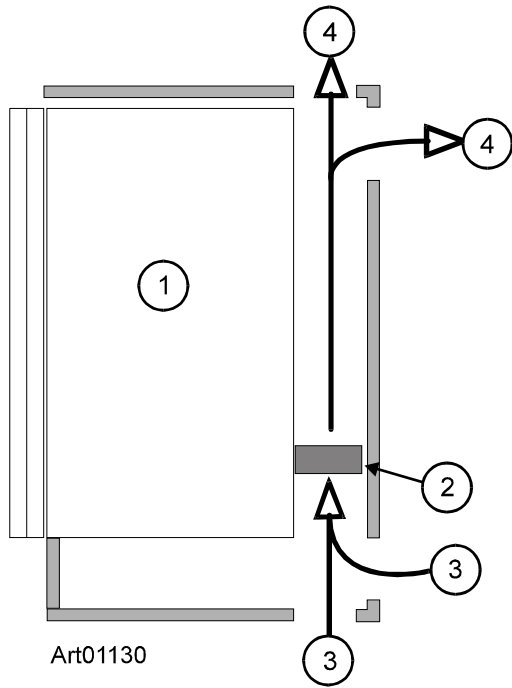

- 1. Side view of refrigerator
- 2. Ventilation Fan
- 3. Air Intake
- 4. Exhaust

## Ventilation - Procedure I

---

VENTILATION REQUIREMENT CHART			
Refrigerator Model	Min. Vent Sizes Without Fan	Min. Vent Sizes With Fan	Recommended Fan CFM
DC440,K,V	50 Square Inches Inlet 50 Square Inches Outlet	25 Square Inches Inlet 25 Square Inches Outlet	28
DC/DE/EV451	50 Square Inches Inlet 50 Square Inches Outlet	25 Square Inches Inlet 25 Square Inches Outlet	28
DE490,V	100 Square Inches Inlet 100 Square Inches Outlet	35 Square Inches Inlet 35 Square Inches Outlet	28
DE/EV441	100 Square Inches Inlet 100 Square Inches Outlet	50 Square Inches Inlet 50 Square Inches Outlet	28
DE/EV461	100 Square Inches Inlet 100 Square Inches Outlet	50 Square Inches Inlet 50 Square Inches Outlet	60

Part Number	Description	Model	AMP
160928900	Fan Only	DE/DC451	.15
160928900	Fan Only	DC440,K,V	.15
160928900	Fan Only	DE490, V	.1
160928900	Fan Only	DE441	.15
160929310	Fan Only	DE461	.15

## Trouble Shooting - Quick Reference

---

1. Check for 12 VDC (supply voltage) at rear of the refrigerator. Turn refrigerator ON, operating voltage is between 10.5 VDC to 32 VDC.

2. Check for voltage (**15 VAC-25 VAC**) at compressor between points A and B. If voltage is not within range, refer to **Procedure C on page 5**.

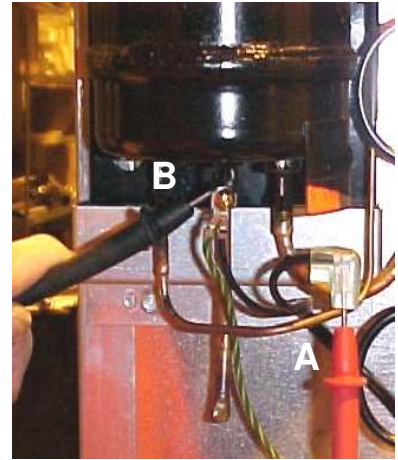

3. Take an Ohm (**2.5-3.5 Ohms**) reading at compressor between points A and B. If Ohms is not within range, refer to **Procedure B on page 4**.

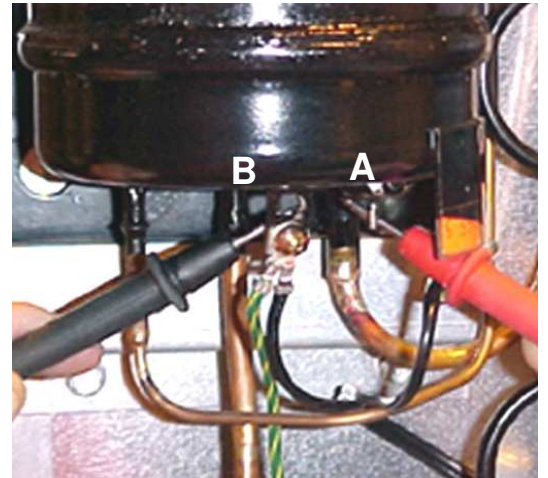

4. Take an Amp (**1.5-2.5 Amps**) reading at the black wire (with rubber boot) connected to the compressor. If Ohms is not within range, refer to **Procedure D on page 6**.



Manual provided courtesy  
Bryant RV Services  
[www.byantrv.com](http://www.byantrv.com)

All manuals are believed to be released for distribution, and/or in the public domain.

Service manuals provided with the understanding that persons using them are well versed in proper safety practices, and are familiar with basic safety procedures, including, but not limited to safety procedures dealing with 120 volt electricity, high amperage 12 volt circuits an LPG (propane) systems.

If in doubt, consult a professional (better safe than sorry).